

# SULZER

Water and wastewater solutions

## Submersible mixer type ABS XRW

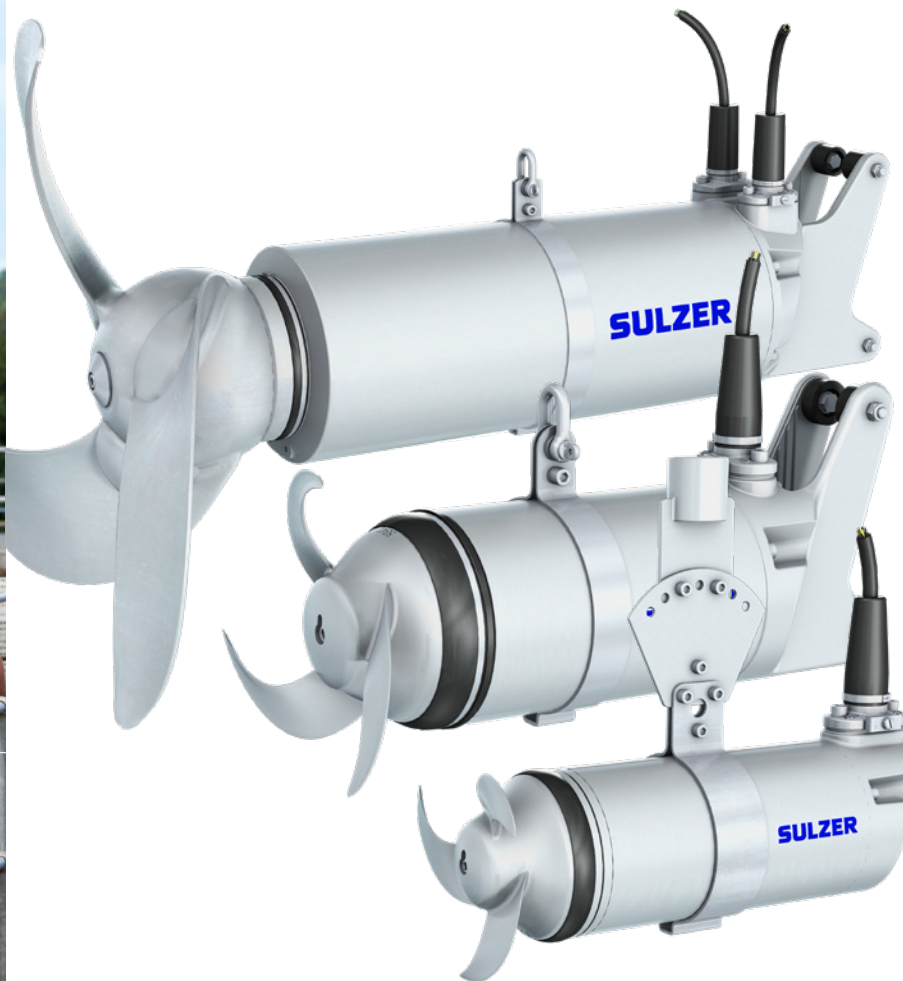

# Main industries and applications

No matter the application or the size of your facility, you need a reliable, cost-effective submersible mixer that is made to work hard, day in and day out — even in the harshest conditions.

Submersible mixers type ABS XRW are robust and reliable, with an average operating life of more than a decade. They are designed to handle mixing and stirring applications in sewage treatment plants, agriculture, paper and pulp mills, and other heavy industries, including in abrasive or acidic liquids.

The XRW series can:

- Equalize sewage
- Aid biological processes (aerobic, anoxic and anaerobic)
- Be used in the selector (contact zone)
- Be used in the sludge buffer tank

They can also homogenize highly-concentrated sludge and slurries, including:

- Primary, secondary and digested sludge in storage and buffer tanks
- Lime and mineral slurries

And are certified for use in hazardous locations:

- Certified for ATEX  
(Ex II 2G Ex h db IIB T4 Gb)
- FM and CSA certification is available



Water and  
wastewater



General  
industry



Pulp, paper and  
board



# Designed to deliver

---

The versatile XRW range of mixers combine high-efficiency motors with propellers that are optimized to consume the least electricity possible. All our XRW mixers feature either IE3 asynchronous, or IE3-equivalent motors, which offers full speed variability and a high overload capacity, while also guaranteeing energy savings, outstanding life-cycle economy, and superior reliability.

## Submersible mixers for large tanks and open waters

The XRW 210 to 900 mixers are a compact, highly efficient mixer range. The multi-blade propellers with two or three blades are designed to achieve high thrust and therefore a high flow capacity. This optimal flow pattern ensures that our XRW mixers handle a wide range of mixing and stirring applications.

For an optimized lifecycle cost, each mixer type is equipped with the most suitable motor speed concept; asynchronous or asynchronous with a gearbox.

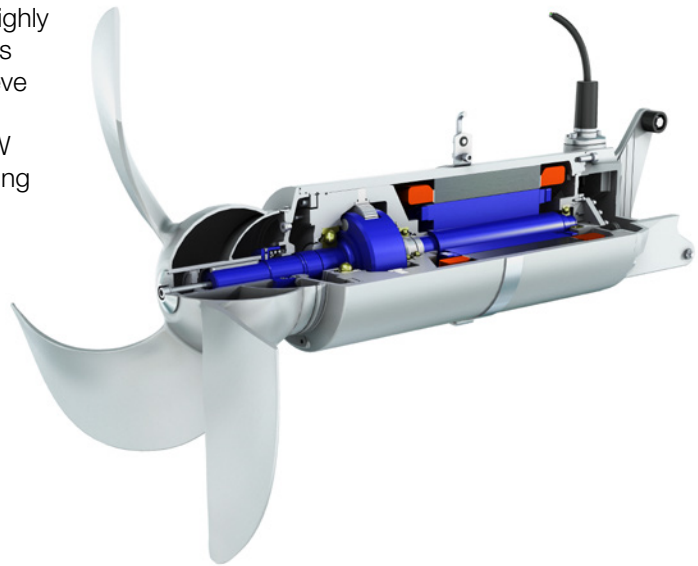

## Mixed-flow propeller handles even the thickest sludge

The dual-blade, mixed-flow propellers of the XRW 750 generates a powerful, radial- and axial-rotating turbulent flow to homogenize highly concentrated sludge and slurry.

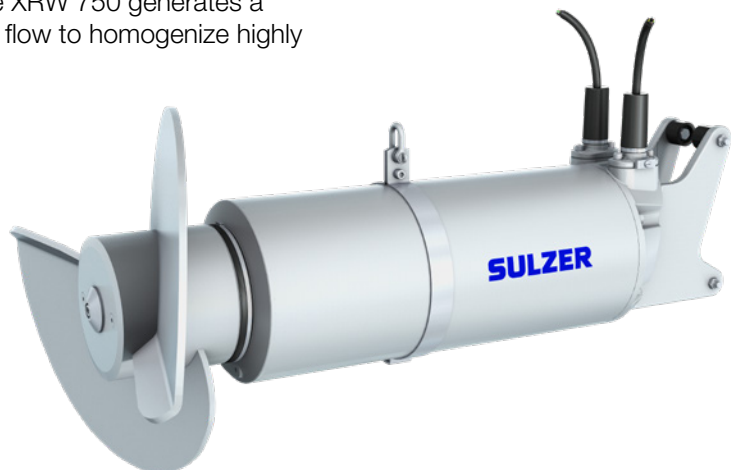

# Features and benefits

## Premium Efficiency motors

- Guarantee the lowest possible energy consumption
- Reduce the operating temperature, extending the product life

## Easy upgrade

- Suitable for use with most guiderails and lifts
- Available with a wide range of brackets and adapters

## Maintenance-free bearings

- Lubricated for life
- Operating lifetime that exceeds 100'000 hours

## Preloaded inner bearings

- Prevent spinning even in massive rag loaded applications with high turbulence
- Eliminate backlash by design, the attached spring always ensures a smooth operation
- Extend bearing life

## Large rotor shafts

- Minimize deflection due to "increased" shaft diameter and stronger bearing set up

## Sealed connection chambers

- Simplify maintenance by reducing the number of nuts, washers, ferrules etc.
- Safeguard the motor
- Ensure reliability because of separated chambers between motor and connection chamber

## Seal systems

- Include a dependable, triple-seal system
- Feature dual oil chambers, to safeguard the motor
- Offer enhanced protection to keep the mechanical seal clog-free and extend its life

## Robust planetary gearbox

- Standard on the XRW 750 and XRW 900
- Fully integrated cartridge box available also in stainless steel mixer executions

## Hydraulic-optimized propeller as standard

- Ensures high-efficient mixing on all XRW mixers

## Investment-cast propeller

- Ensure the best possible mixing performance
- Self-clean to reduce maintenance
- Available for XRW 210 and XRW 300

## Multiple moisture sensor (DI) seal monitoring

- Secures full protection for the motor and gearbox

## Abrasion-resistant, galvanically-insulated mast bracket and suspension

- Reduces the risk of electrochemical corrosion

## TCS (Thermo Control System)

- Provides a warning and switches off the motor, if necessary, to prevent overheating



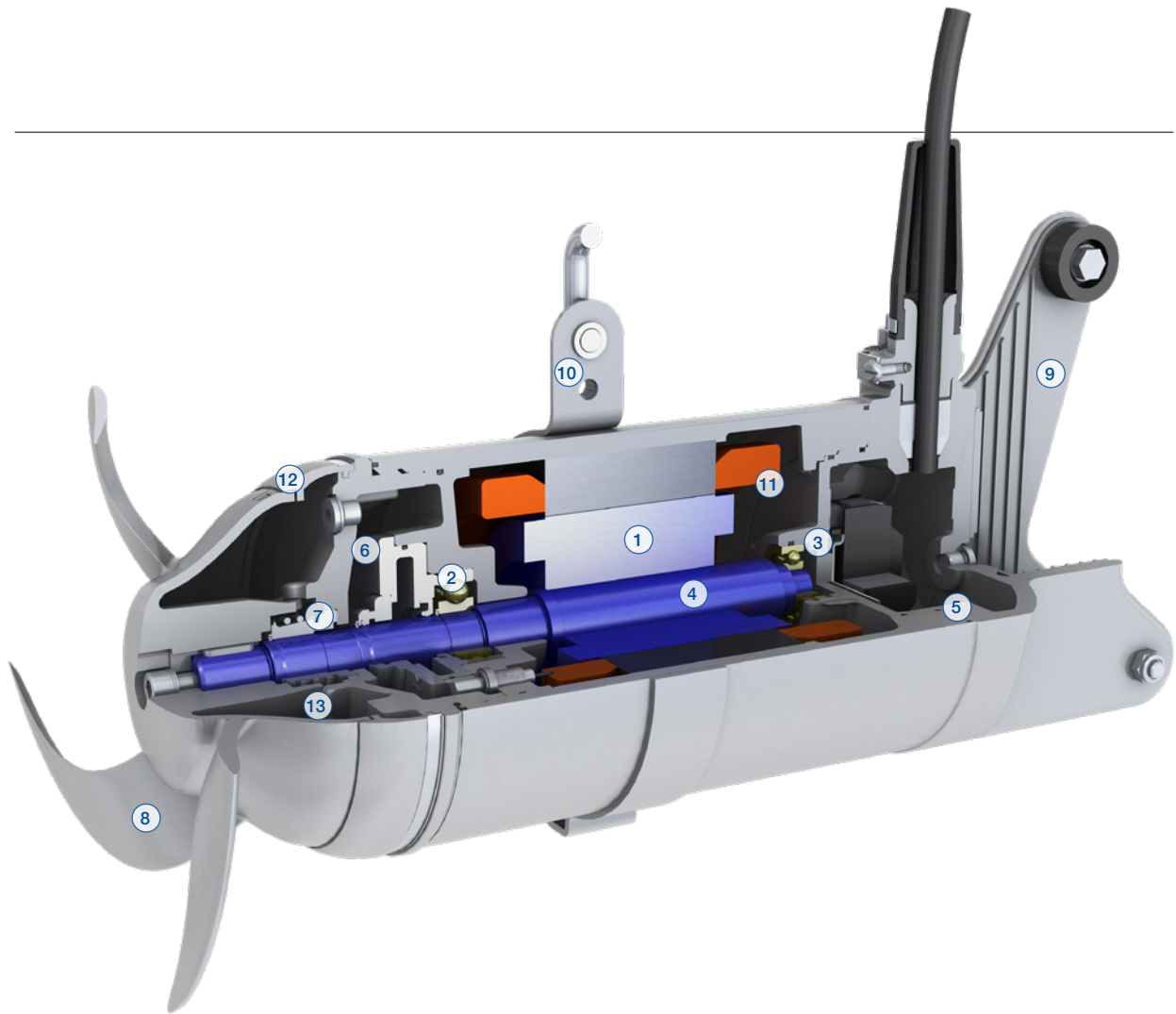
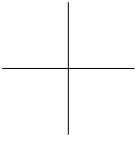

- |                                 |                                     |
|---------------------------------|-------------------------------------|
| ① Premium Efficiency motor      | ⑧ Propeller                         |
| ② Outer bearing                 | ⑨ Mast bracket                      |
| ③ Preloaded inner bearing       | ⑩ Lift bracket                      |
| ④ Rotor shaft                   | ⑪ TCS (Thermo Control System)       |
| ⑤ Sealed connection chamber     | ⑫ Solids deflection ring            |
| ⑥ Dual oil chamber              | ⑬ Integrated seal protection system |
| ⑦ Triple mechanical seal system |                                     |

# Model and feature comparison

Standard feature	XRW 210-300	XRW 750-900
Premium Efficiency IE3 motor	●	●
Premium Efficiency IE3-equivalent motor		
Variable-frequency drive (VFD), IP55 / IP21		
Planetary gearbox		●
Sealed connection chamber	●	●
Stainless steel fabricated propeller		●
Investment-cast propeller	●	
Moisture sensor (DI) seal monitoring	●	●
TCS (Thermo Control System)	●	●
De-rag function	●	●

## We're more than your partner in better wastewater management

We're your partner in better business. We take the time to understand your facility's unique situation, so we can create the best solution for you, based on the right size unit, before we even visit your site. Once there, we can adjust our mixers to meet your demands, ensuring the perfect balance of speed, power, and efficiency.

**For more information about our XRW mixer series, visit [sulzer.com](http://sulzer.com).**



# Materials

Mixer part	CR (stainless steel)	EC (cast iron)
Motor housing	1.4404 (AISI 316L)	EN-GJL-250 painted
Motor shaft XRW 210 - 300	1.4401 (AISI 316)	1.4021 (AISI 420)
Motor shaft / propeller shaft XRW 750 - 900	1.4021 / EN-GJS-700-3 (AISI 420 / ASTM - AISI, 100-70-03)	1.4021 / EN-GJS-700-3 (AISI 420 / ASTM - AISI, 100-70-03)
Propeller XRW 210 - 300	1.4460 (AISI 329)	1.4460 (AISI 329)
Propeller XRW 750 - 900	1.4571 (AISI 316 Ti)	1.4571 (AISI 316 Ti)
Fasteners	1.4401 (AISI 316)	1.4401 (AISI 316)

## Operating data

	60 Hz (IE2* / IE3 or equivalent**)
Propeller diameter	8 to 35 in.
Motor power	1.2 to 33.5 hp
Motor efficiency	up to 93%
Mixing flow	up to 28'300 USgpm

\* IE2 only valid for XRW 300, 60 Hz

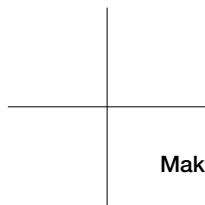

---

**Making water go around. Water and wastewater solutions by Sulzer.**

---

Sulzer offers a broad range of pumps and related equipment for water production and transportation as well as wastewater collection and treatment for municipalities and industries. Our expertise also includes separation technologies, and services on rotating equipment.

---

E10789 us 8.2022, Copyright © Sulzer Ltd 2022

This brochure is a general presentation. It does not provide any warranty or guarantee of any kind. Please, contact us for a description of the warranties and guarantees offered with our products. Directions for use and safety will be given separately. All information herein is subject to change without notice.

