

Type Typ Type 50Hz	Weight Gewicht Poids NCJ (~kg)	Weight Gewicht Poids WCJ (~kg)	H (mm)
PE 220/4	410	460	1349
PE 300/4	440	490	

Weight: Includes pump and 10m cable
 Gewicht: Beinhaltet Pumpe und 10m Kabel
 Poids: Pompe et 10m de câble
 For different cable length see IOM.
 Für abweichende Kabellänge siehe EBA.
 Pour des longueurs câble supérieures, voir du manuel.

Minimum water level for operation - Non Cooling Jacket (NCJ)

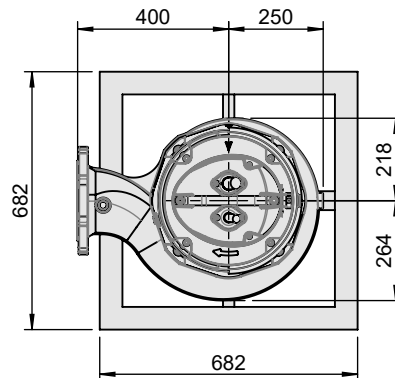
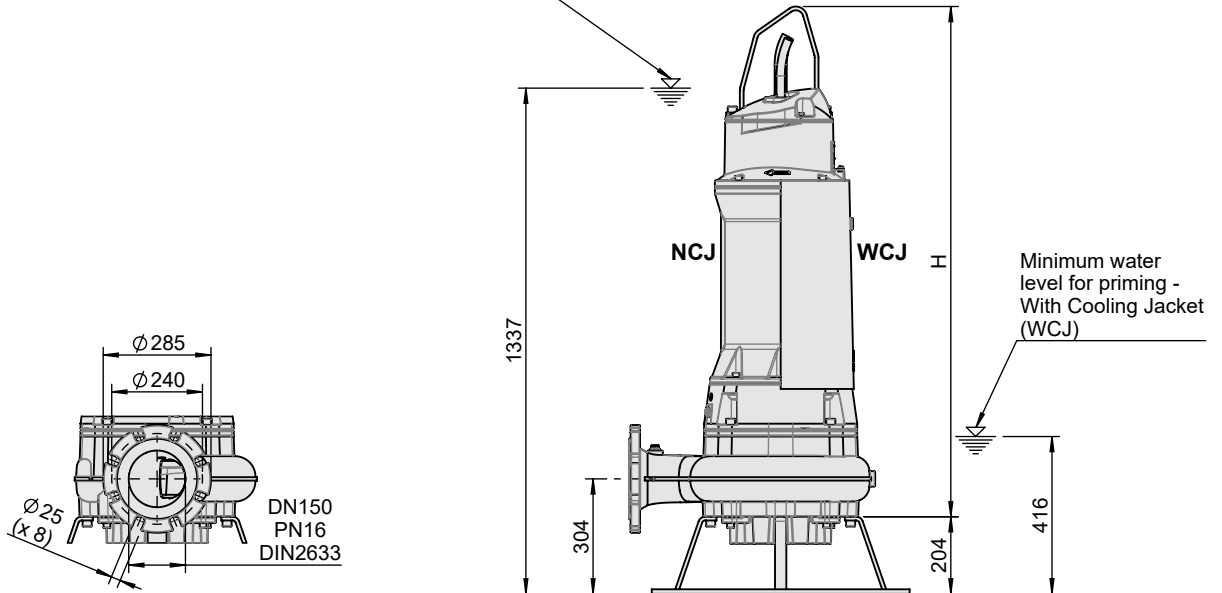

NCJ = Non cooling jacket
 Ohne Kühlmantel
 Sans enveloppe de refroidissement

WCJ = With cooling jacket
 Mit Kühlmantel
 Avec enveloppe de refroidissement